

Il kit comprende:

- N°1 Coppia di carrelli con dispositivo di sicurezza
- N°2 Stopper per anta
- N°4 Attacchi a vetro fisso per binario
- N°1 Binario di scorrimento
- N°2 Supporti per binario di scorrimento a parete
- N°2 Guide inferiori per anta con innesto per vetro fisso e profilo ferma acqua
- N°2 Guarnizioni ad aletta laterale 25 mm per spessore vetro indicato
- N°1 Profilo ferma acqua 15x15 mm (lunghezza 1000 mm)

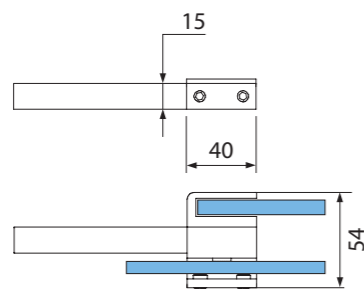

GUIDA PAVIMENTO CON PROFILO FERMA ACQUA

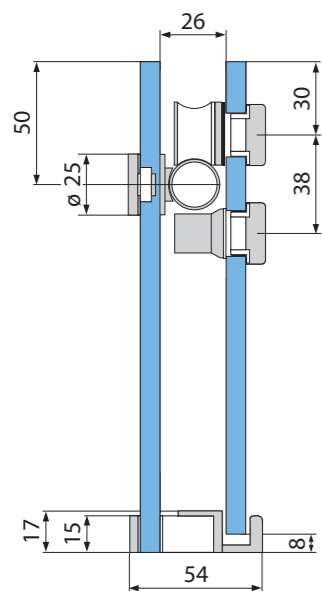
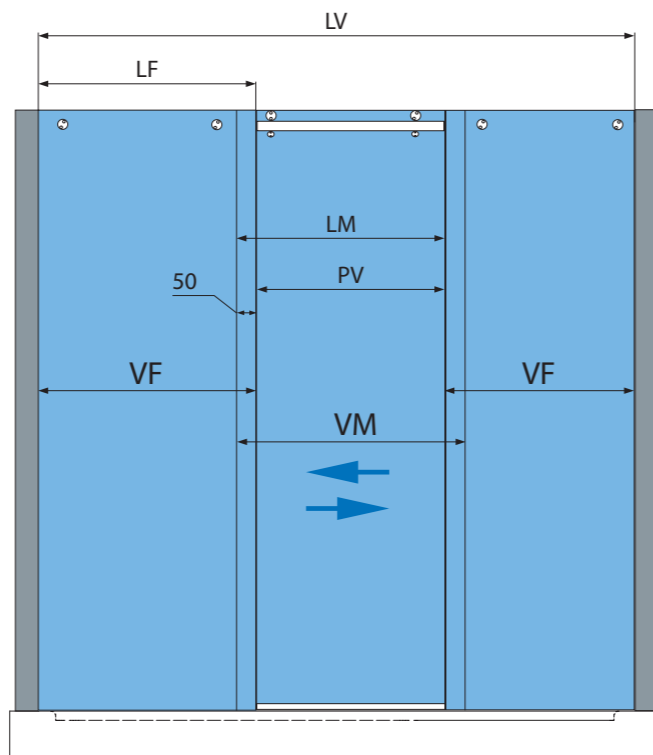

HF = Altezza anta fissa  
 HM = Altezza anta mobile  
 LF = Larghezza anta fissa  
 LM = Larghezza anta mobile  
 LB = Lunghezza binario  
 LV = Larghezza vano

VF = Vetro fisso  
 VM = Vetro mobile

$$LM/LF = LV + 100/3$$

$$LB = LV - 30$$

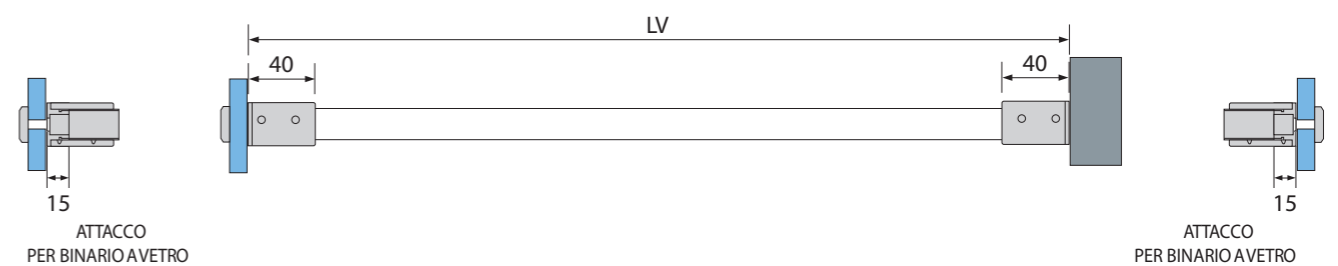
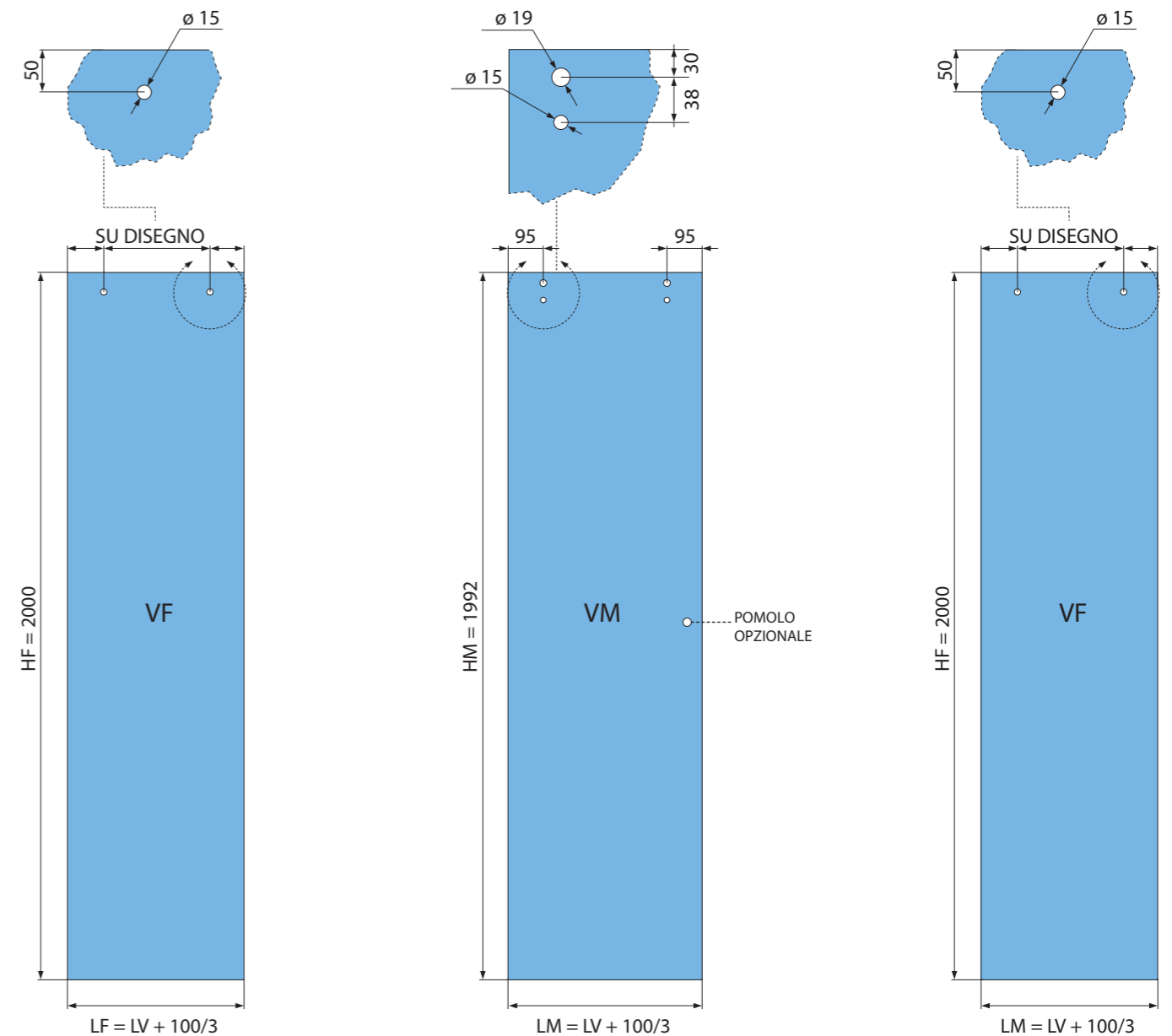

SCHEMA A - PROFILO FERMA ACQUA

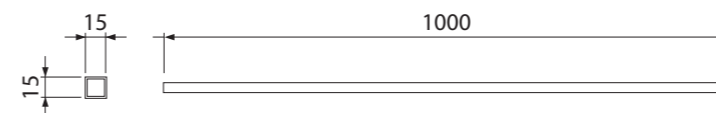

 Tagliare il profilo ferma acqua in base all'esigenza

SCHEMA B - BINARIO DI SCORRIMENTO

